





RM87N SMT

miniature relays



- Cadmium - free contacts
- Height 17,7 mm
- 5000 V / 10 mm reinforced insulation
- **For surface mounting SMT** - for manual soldering
- AC and DC coils
- Compliance with standard PN-EN 60335-1
- Recognitions, certifications, directives: RoHS,     

Contact data

Number and type of contacts		1 CO, 1 NO
Contact material		AgNi , AgNi/Au 5 µm, AgSnO ₂
Rated / max. switching voltage	AC	250 V / 440 V
Min. switching voltage		5 V AgNi, 5 V AgNi/Au 5 µm, 10 V AgSnO ₂
Rated load (capacity)	AC1	12 A / 250 V AC
	AC15	3 A / 120 V 1,5 A / 240 V (B300)
	AC3	750 W (single-phase motor)
	DC1	12 A / 24 V DC (see Fig. 3)
	DC13	0,22 A / 120 V 0,1 A / 250 V (R300)
Min. switching current		5 mA AgNi, 2 mA AgNi/Au 5 µm, 10 mA AgSnO ₂
Max. inrush current		25 A AgSnO ₂
Rated current		12 A
Max. breaking capacity	AC1	3 000 VA
Min. breaking capacity		0,3 W AgNi, 0,05 W AgNi/Au 5 µm, 1 W AgSnO ₂
Contact resistance		≤ 100 mΩ
Max. operating frequency		
• at rated load	AC1	600 cycles/hour
• no load		72 000 cycles/hour

Coil data

Rated voltage	50/60 Hz AC	12 ... 240 V
	DC	3 ... 110 V
Must release voltage		AC: ≥ 0,15 U _n DC: ≥ 0,1 U _n
Operating range of supply voltage		see Tables 1, 2 and Fig. 4, 5
Rated power consumption	AC	0,75 VA
	DC	0,4 ... 0,48 W

Insulation according to PN-EN 60664-1

Insulation rated voltage		400 V AC
Rated surge voltage		4 000 V 1,2 / 50 µs
Overvoltage category		III
Insulation pollution degree		3
Dielectric strength		
• between coil and contacts		5 000 V AC type of insulation: reinforced
• contact clearance		1 000 V AC type of clearance: micro-disconnection
Contact - coil distance		
• clearance		≥ 10 mm
• creepage		≥ 10 mm

General data

Operating / release time (typical values)		7 ms / 3 ms
Electrical life (number of cycles)		
• resistive AC1		> 10 ⁵ 12 A, 250 V AC
• cosφ		see Fig. 2
• DC L/R=40 ms		> 10 ⁵ 0,15 A, 220 V DC
Mechanical life (cycles)		> 3 x 10 ⁷
Dimensions (L x W x H)		29 x 13,2 x 17,7 mm
Weight		14 g
Ambient temperature	• storage	-40...+85 °C
	• operating	AC: -40...+70 °C DC: -40...+85 °C
Cover protection category		IP 40 PN-EN 60529
Environmental protection		RTII PN-EN 116000-3
Shock resistance		30 g
Vibration resistance		10 g 10...150 Hz
Soldering temperature		max. 350 °C
Soldering time		max. 3 s

The data in bold type pertain to the standard versions of the relays.

RM87N SMT

miniature relays

Coil data - DC voltage version

Table 1

Coil code	Rated voltage V DC	Coil resistance at 20 °C Ω	Acceptable resistance	Coil operating range V DC	
				min. (at 20 °C)	max. (at 20 °C)
1003	3	22	$\pm 10\%$	2,1	7,6
1005	5	60	$\pm 10\%$	3,5	12,7
1006	6	90	$\pm 10\%$	4,2	15,3
1009	9	200	$\pm 10\%$	6,3	22,9
1012	12	360	$\pm 10\%$	8,4	30,6
1018	18	710	$\pm 10\%$	12,6	45,9
1024	24	1 440	$\pm 10\%$	16,8	61,2
1036	36	3 140	$\pm 10\%$	25,2	91,8
1048	48	5 700	$\pm 10\%$	33,6	122,4
1060	60	7 500	$\pm 10\%$	42,0	153,0
1110	110	25 200	$\pm 10\%$	77,0	280,0

Coil data - AC 50/60 Hz voltage version

Table 2

Coil code	Rated voltage V AC	Coil resistance at 20 °C Ω	Acceptable resistance	Coil operating range V AC 50 Hz	
				min. (at 20 °C)	max. (at 20 °C)
5012	12	100	$\pm 10\%$	9,6	13,2
5024	24	400	$\pm 10\%$	19,2	28,8
5048	48	1 550	$\pm 10\%$	38,4	57,6
5060	60	2 600	$\pm 10\%$	48,0	72,0
5110	110	8 900	$\pm 10\%$	88,0	132,0
5115	115	9 600	$\pm 10\%$	92,0	138,0
5120	120	10 200	$\pm 10\%$	96,0	144,0
5220	220	35 500	$\pm 10\%$	176,0	264,0
5230	230	38 500	$\pm 10\%$	184,0	276,0
5240	240	42 500	$\pm 15\%$	192,0	288,0

Dimensions

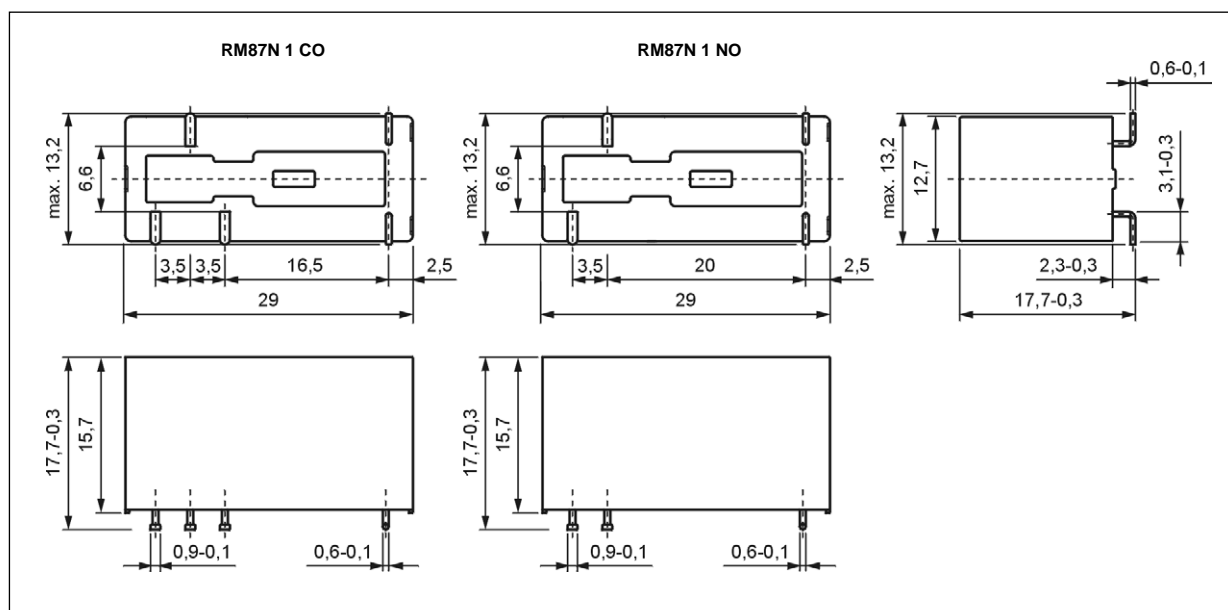

23.05.2013

Electrical life at AC resistive load.
Switching frequency: 600 cycles/hour

Fig. 1

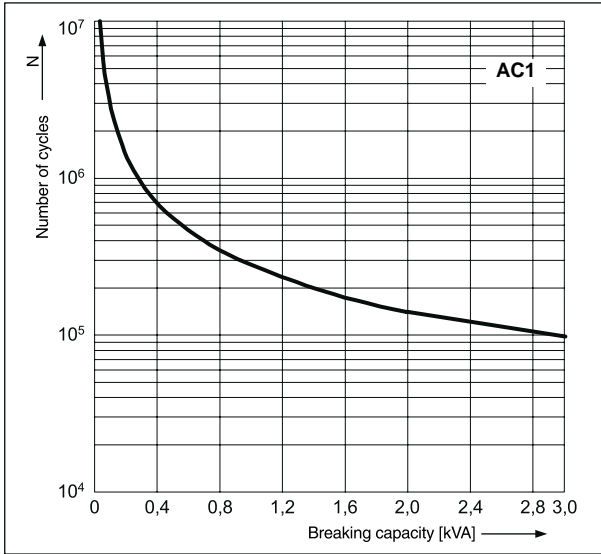

Electrical life reduction factor at AC inductive load

Fig. 2

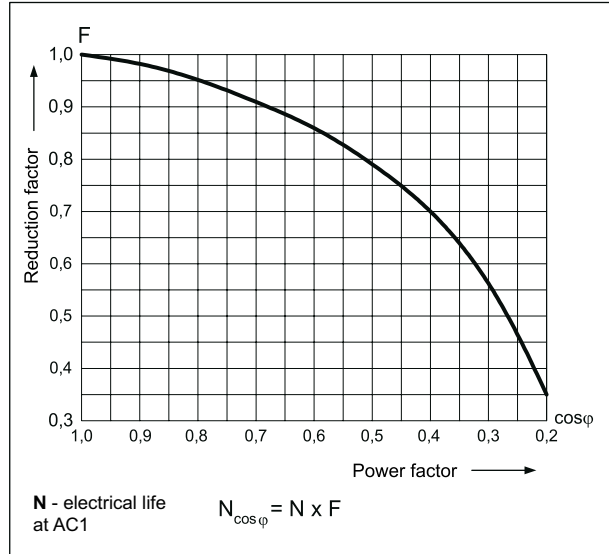

Max. DC resistive load breaking capacity

Fig. 3

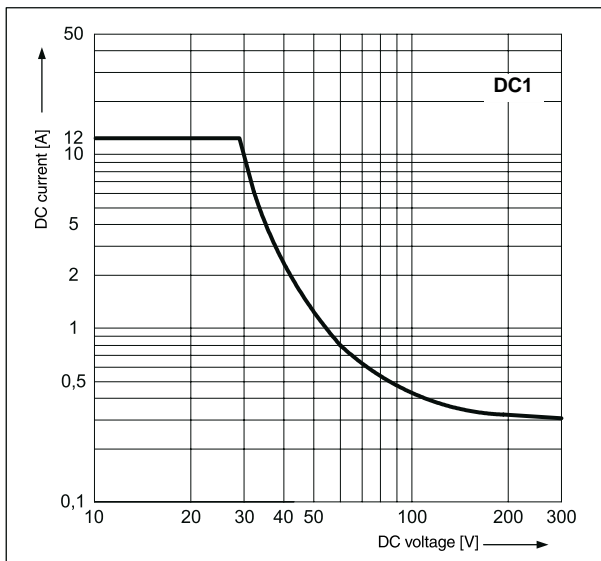

Coil operating range - DC

Fig. 4

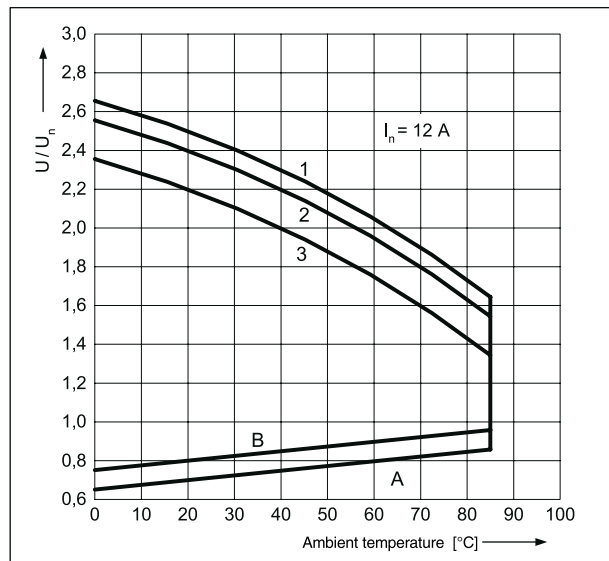

Coil operating range - AC 50 Hz

Fig. 5

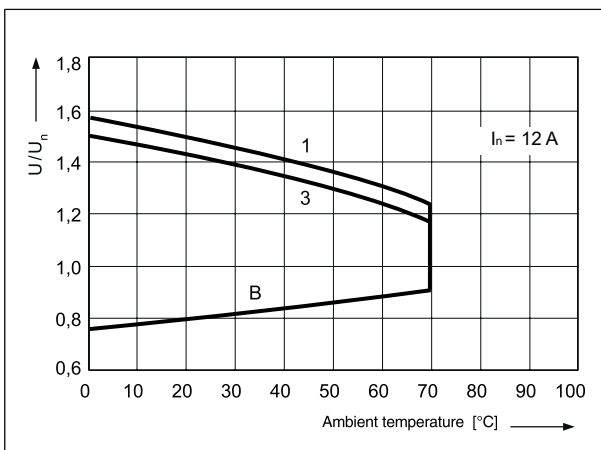

Description of Fig. 4 and 5

A - relations between make voltage and ambient temperature at no load on contacts. Coil temperature and ambient temperature are equal before coil energizing. Make voltage is not higher than the value read on Y axis (multiplication of rated voltage).

B - relations between make voltage and ambient temperature after initial coil heating up with $1,1 U_n$ at continues load of I_n on contacts. Make voltage is not higher than the value read on Y axis (multiplication of rated voltage).

1, 2, 3 - values on Y axis represent allowed overvoltage on coil at certain ambient temperature and contact load:

- 1 - no load
- 2 - 50% of rated load
- 3 - rated load

RM87N SMT

miniature relays

Connection diagrams (pin side view)

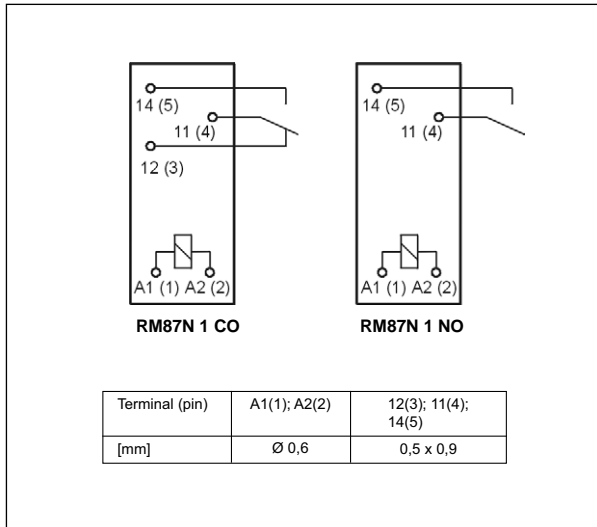

Soldering areas (solder side view)

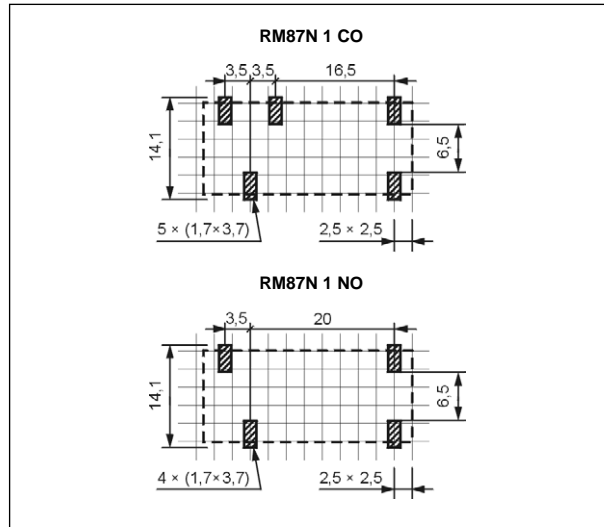

Mounting

Relays **RM87N SMT** are designed for surface mounting SMT - for manual soldering.

Ordering codes

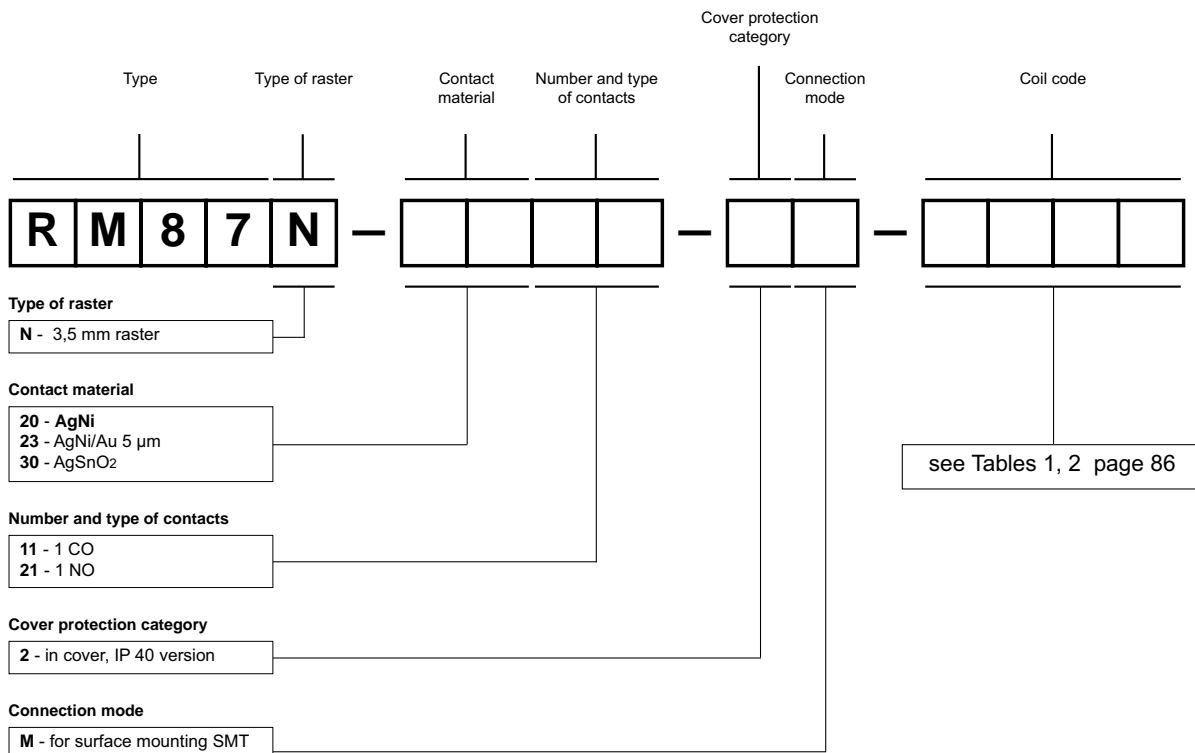

Examples of ordering code:

RM87N-2011-2M-1024 relay **RM87N SMT**, 3,5 mm raster, for surface mounting SMT, one changeover contact, contact material AgNi, coil voltage 24 V DC, in cover IP 40

RM87N-2321-2M-5012 relay **RM87N SMT**, 3,5 mm raster, for surface mounting SMT, one normally open contact, contact material AgNi/Au 5 μm, coil voltage 12 V AC 50/60 Hz, in cover IP 40

PRECAUTIONS:

1. Ensure that the parameters of the product described in its specification provide a safety margin for the appropriate operation of the device or system and never use the product in circumstances which exceed the parameters of the product. 2. Never touch any live parts of the device. 3. Ensure that the product has been connected correctly. An incorrect connection may cause malfunction, excessive heating or risk of fire. 4. In case of any risk of any serious material loss or death or injuries of humans or animals, the devices or systems shall be designed so to equip them with double safety system to guarantee their reliable operation.